

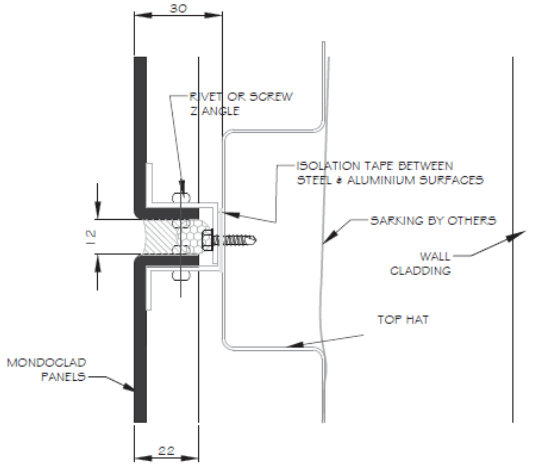

MondoClad™

FIXING SYSTEMS – FOLDED



04 HORIZONTAL JOINT DETAIL Z ANGLE

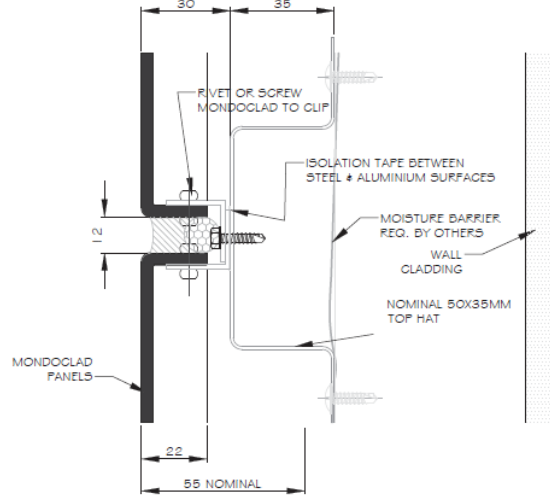

04 HORIZONTAL JOINT DETAIL

THIS INFORMATION IS GENERIC IN NATURE & SUPPLIED FOR GUIDANCE PURPOSES ONLY. JOINT WIDTHS WILL VARY TO SUIT PANEL SIZE & SEALANT USED. TOP HAT DIMENSIONS ARE NOMINAL. DIMENSIONS, SPACING, SPANS & STIFFENER REQUIREMENTS WILL NEED TO BE CONFIRMED BY A SUITABLY QUALIFIED PROFESSIONAL TO SUIT THE SPECIFIC APPLICATION.	HORIZONTAL JOINT DETAIL Z ANGLE	FIXED CASSETTE FOLD SYSTEM
---	---------------------------------	----------------------------

THIS INFORMATION IS GENERIC IN NATURE & SUPPLIED FOR GUIDANCE PURPOSES ONLY. JOINT WIDTHS WILL VARY TO SUIT PANEL SIZE & SEALANT USED. TOP HAT DIMENSIONS ARE NOMINAL. DIMENSIONS, SPACING, SPANS & STIFFENER REQUIREMENTS WILL NEED TO BE CONFIRMED BY A SUITABLY QUALIFIED PROFESSIONAL TO SUIT THE SPECIFIC APPLICATION.	HORIZONTAL JOINT DETAIL	FIXED CASSETTE FOLD SYSTEM
---	-------------------------	----------------------------

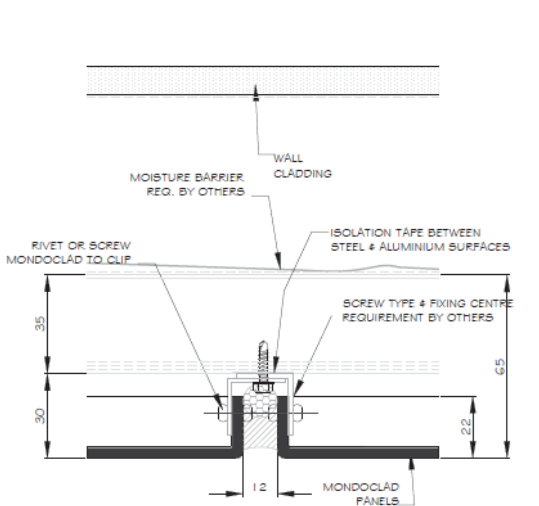

05 VERTICAL JOINT

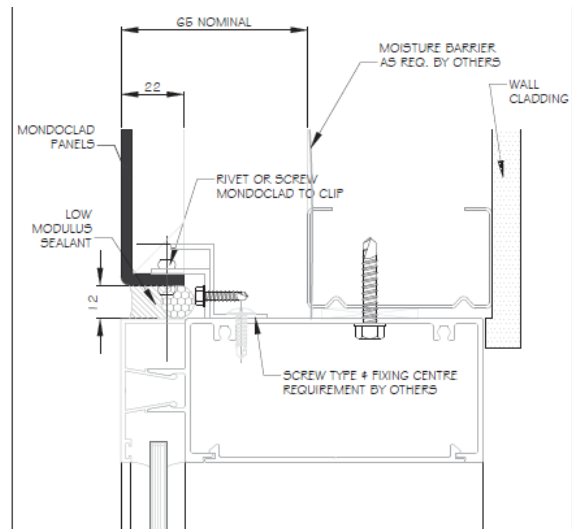

02 WINDOW HEAD DETAIL

THIS INFORMATION IS GENERIC IN NATURE & SUPPLIED FOR GUIDANCE PURPOSES ONLY. JOINT WIDTHS WILL VARY TO SUIT PANEL SIZE & SEALANT USED. TOP HAT DIMENSIONS ARE NOMINAL. DIMENSIONS, SPACING, SPANS & STIFFENER REQUIREMENTS WILL NEED TO BE CONFIRMED BY A SUITABLY QUALIFIED PROFESSIONAL TO SUIT THE SPECIFIC APPLICATION.	VERTICAL JOINT DETAIL	FIXED CASSETTE FOLD SYSTEM
---	-----------------------	----------------------------

THIS INFORMATION IS GENERIC IN NATURE & SUPPLIED FOR GUIDANCE PURPOSES ONLY. JOINT WIDTHS WILL VARY TO SUIT PANEL SIZE & SEALANT USED. TOP HAT DIMENSIONS ARE NOMINAL. DIMENSIONS, SPACING, SPANS & STIFFENER REQUIREMENTS WILL NEED TO BE CONFIRMED BY A SUITABLY QUALIFIED PROFESSIONAL TO SUIT THE SPECIFIC APPLICATION.	WINDOW HEAD DETAIL	FIXED CASSETTE FOLD SYSTEM
---	--------------------	----------------------------



MondoClad™

FIXING SYSTEMS – FOLDED

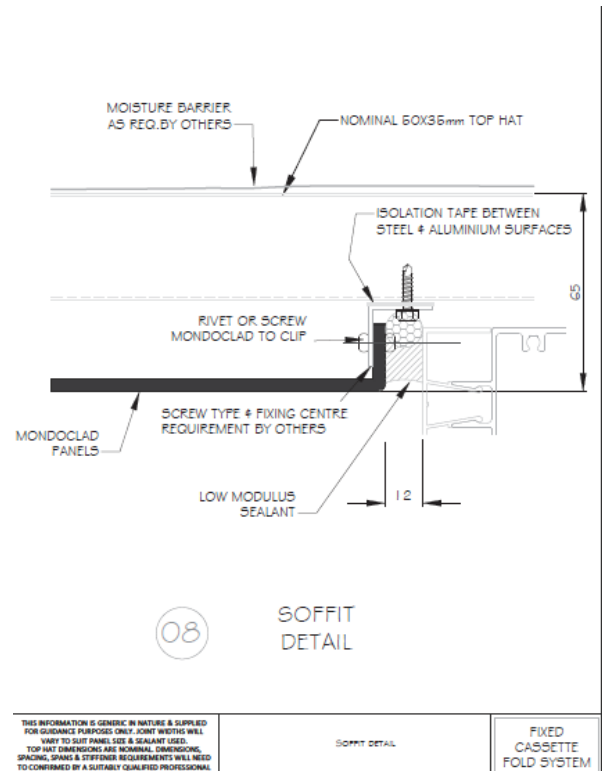
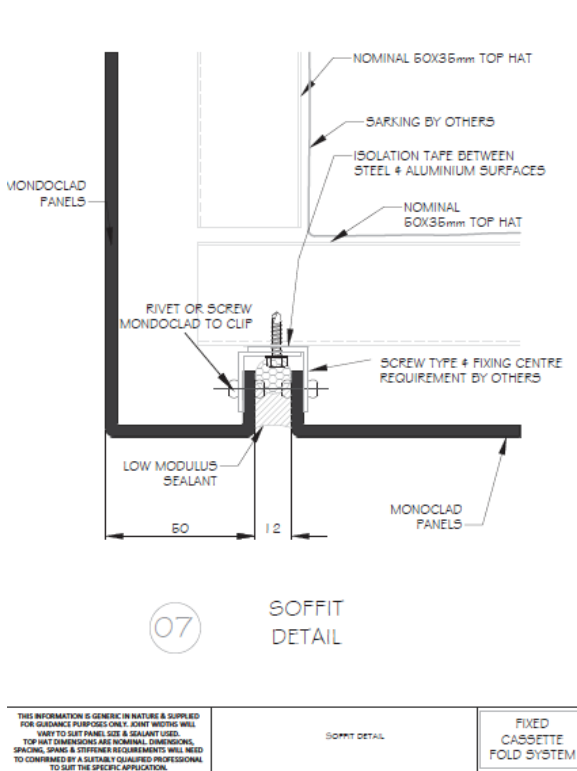
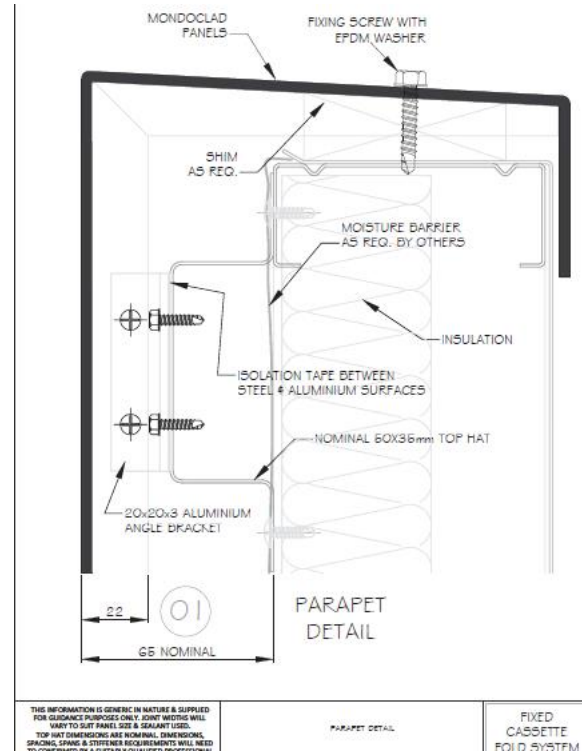
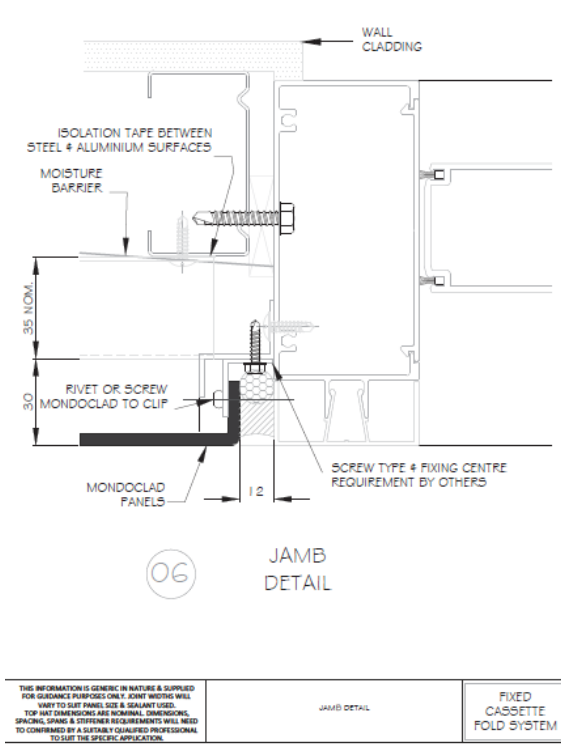

FIXING SYSTEMS – FOLDED

