

Vertical Cladding Wall Layout

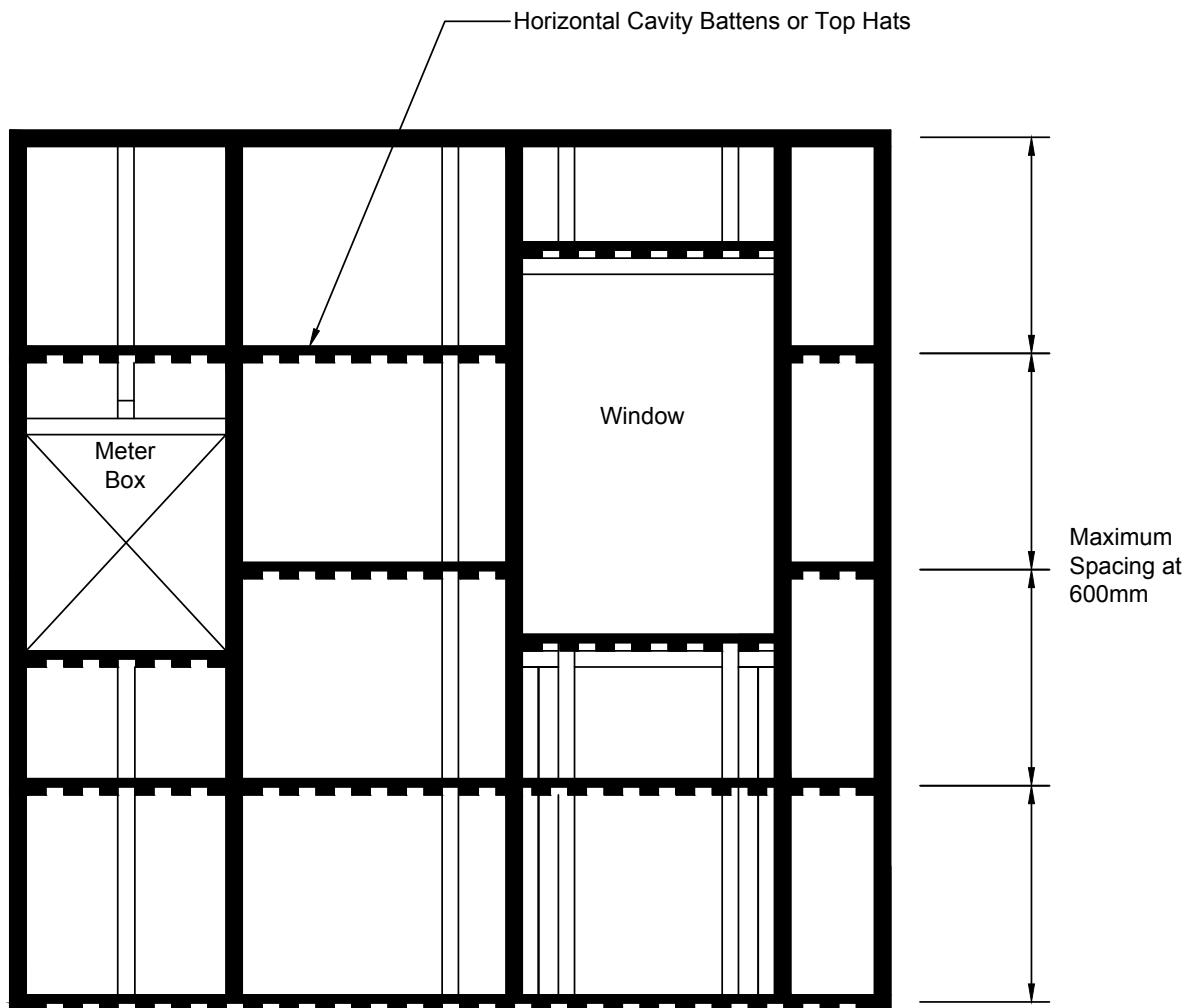

TYPICAL VERTICAL FIXING DETAIL

This information is generic in nature and supplied for guidance purposes only. Top Hat dimensions are nominal. Dimensions, spacing, spans and stiffener requirements will need to be confirmed by a suitably qualified professional to suit the specific application.

By **HVG** façades

hvgfacades.com.au

1300 881 712

info@hvgfacades.com.au

Vertical Cladding Wall Starter

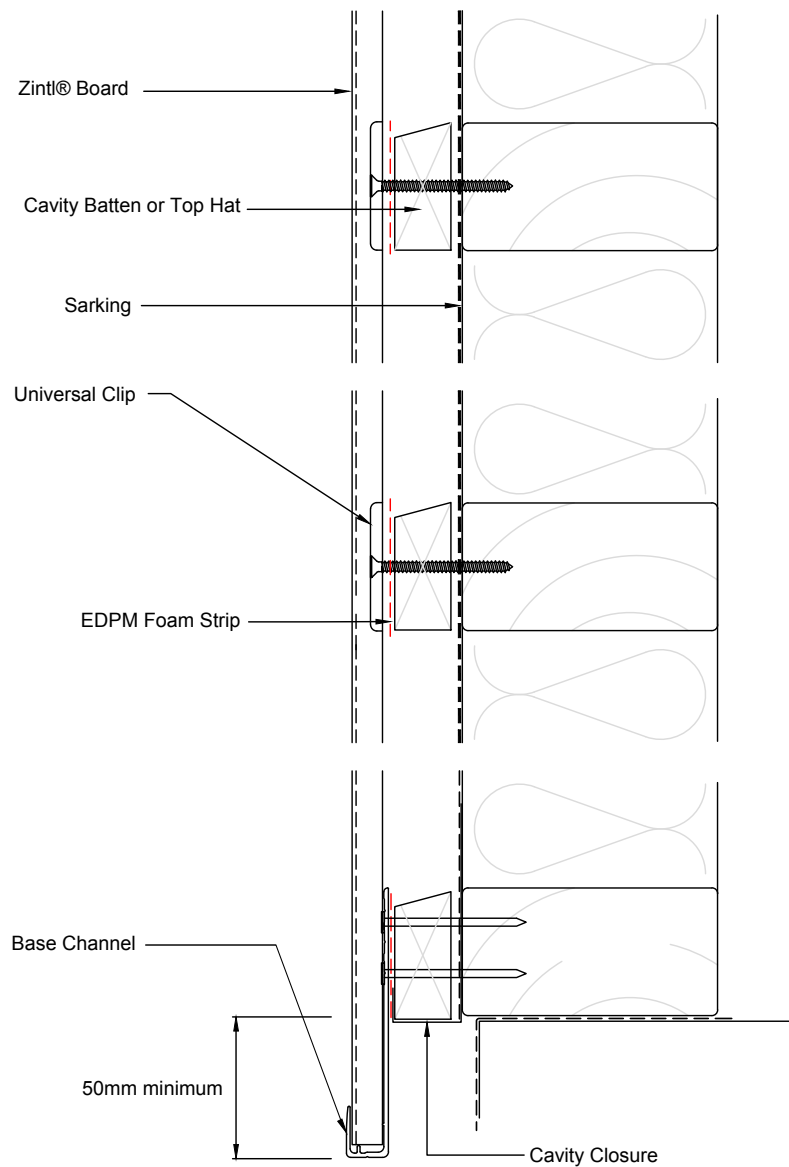

TYPICAL VERTICAL FIXING DETAIL

This information is generic in nature and supplied for guidance purposes only. Top Hat dimensions are nominal. Dimensions, spacing, spans and stiffener requirements will need to be confirmed by a suitably qualified professional to suit the specific application.

By **HVG** façades

hvgfacades.com.au

1300 881 712

info@hvgfacades.com.au

Vertical Cladding External Corner

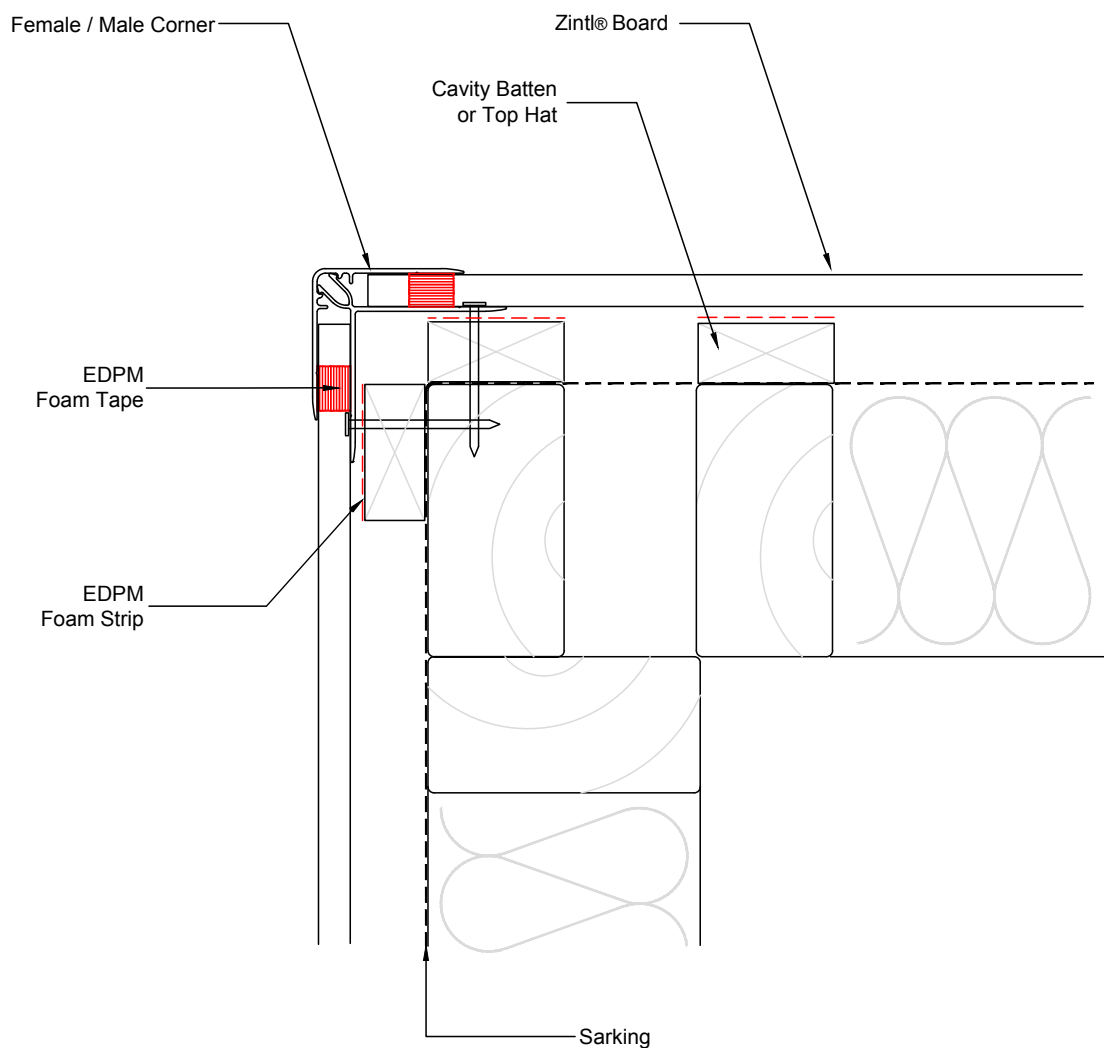

TYPICAL VERTICAL FIXING DETAIL

This information is generic in nature and supplied for guidance purposes only. Top Hat dimensions are nominal. Dimensions, spacing, spans and stiffener requirements will need to be confirmed by a suitably qualified professional to suit the specific application.

By **HVG** façades

hvgfacades.com.au

1300 881 712

info@hvgfacades.com.au

Vertical Cladding Internal Corner

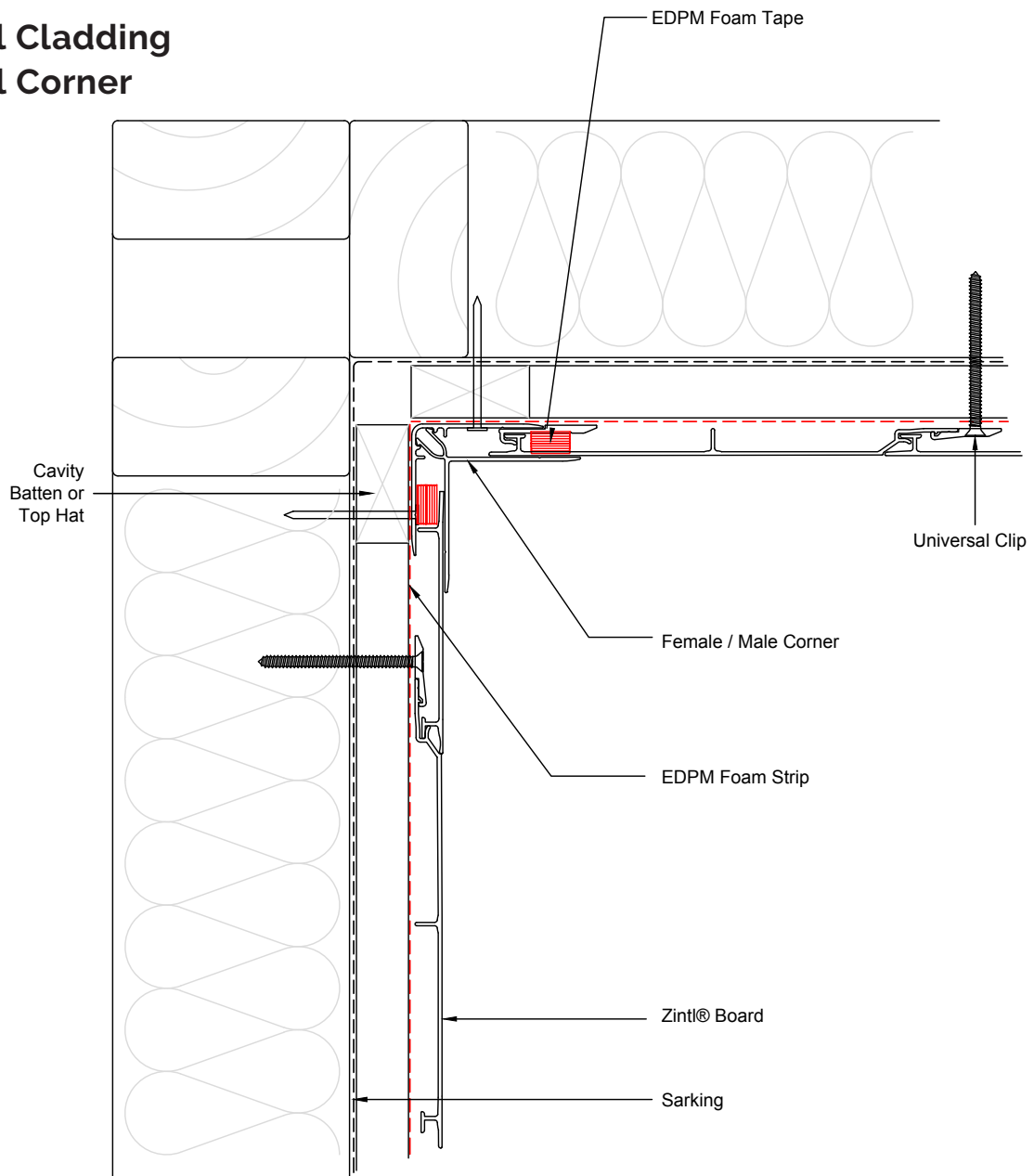

TYPICAL VERTICAL FIXING DETAIL

This information is generic in nature and supplied for guidance purposes only. Top Hat dimensions are nominal. Dimensions, spacing, spans and stiffener requirements will need to be confirmed by a suitably qualified professional to suit the specific application.

By **HVG** façades

hvgfacades.com.au

1300 881 712

info@hvgfacades.com.au

Vertical Cladding Inter-Storey Joints

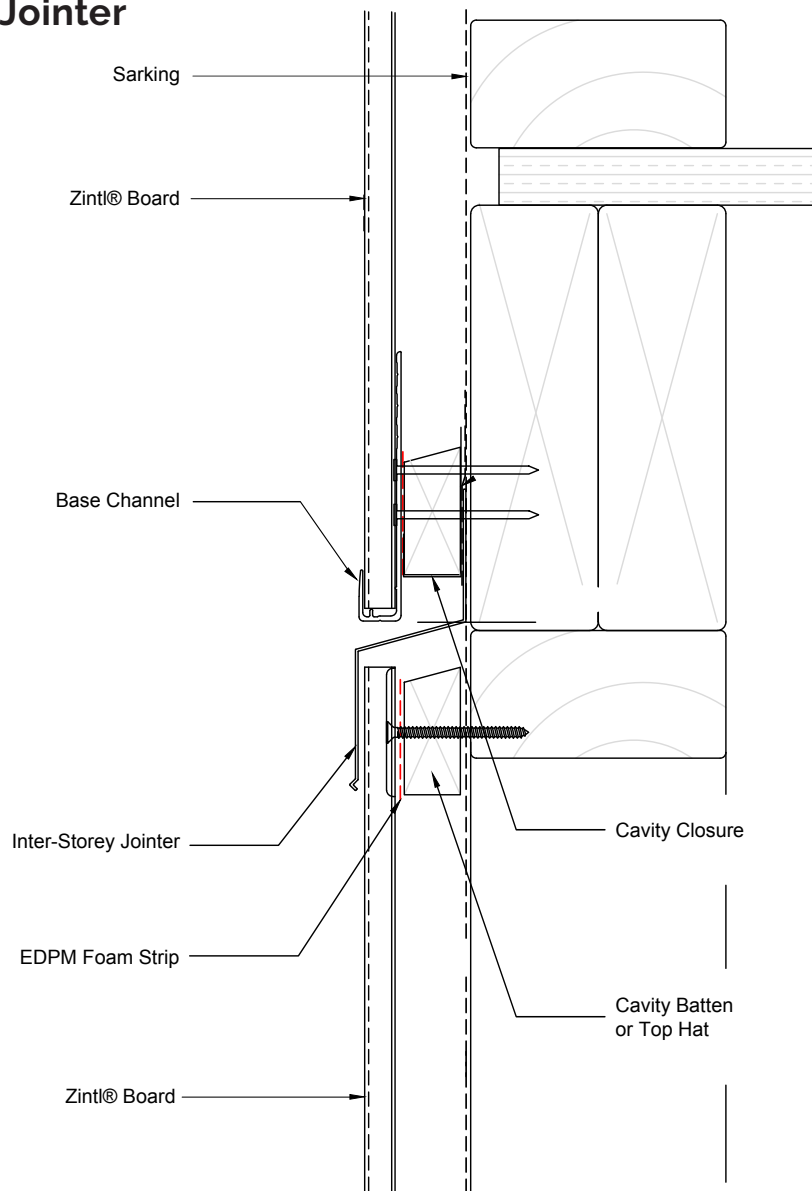

TYPICAL VERTICAL FIXING DETAIL

This information is generic in nature and supplied for guidance purposes only. Top Hat dimensions are nominal. Dimensions, spacing, spans and stiffener requirements will need to be confirmed by a suitably qualified professional to suit the specific application.

By **HVG** façades

hvgfacades.com.au

1300 881 712

info@hvgfacades.com.au

Vertical Cladding Window Sill

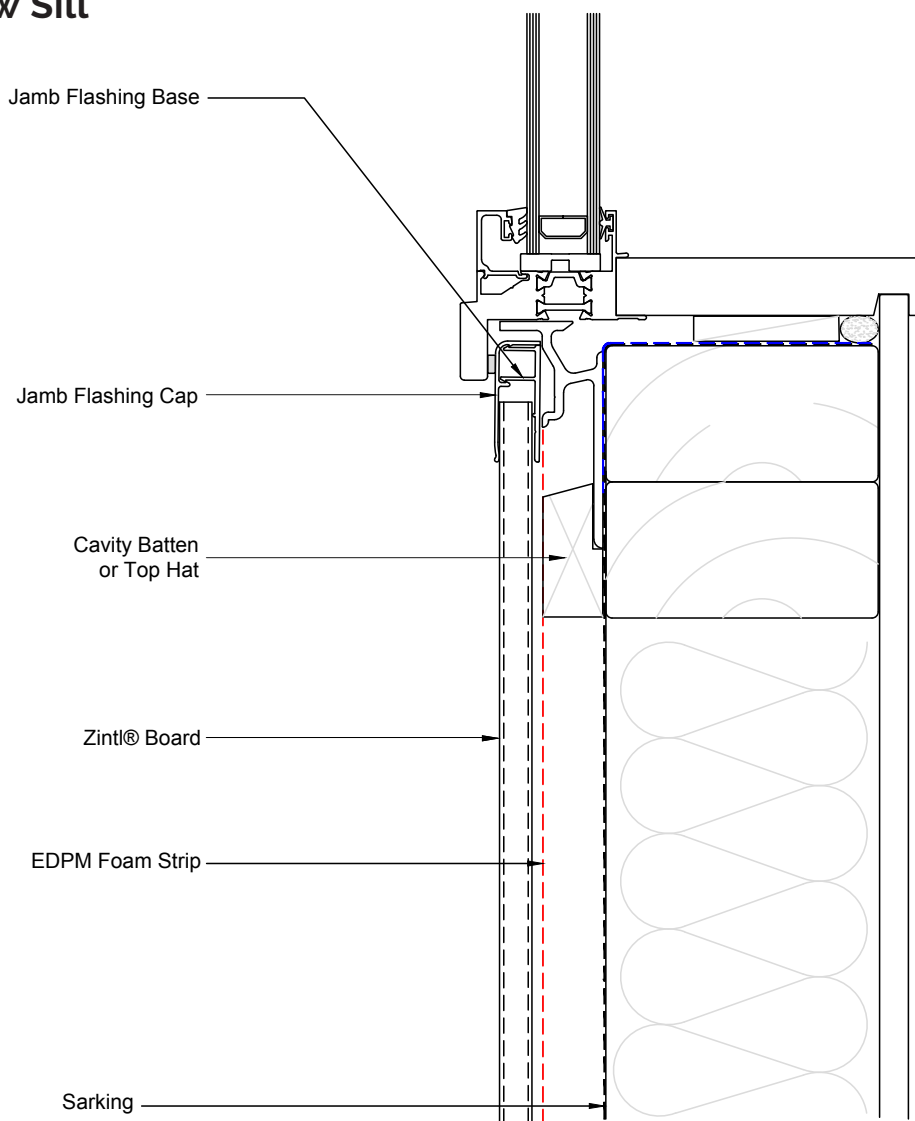

TYPICAL VERTICAL FIXING DETAIL

This information is generic in nature and supplied for guidance purposes only. Top Hat dimensions are nominal. Dimensions, spacing, spans and stiffener requirements will need to be confirmed by a suitably qualified professional to suit the specific application.

By **HVG** façades

hvgfacades.com.au

1300 881 712

info@hvgfacades.com.au

Vertical Cladding Window Jamb

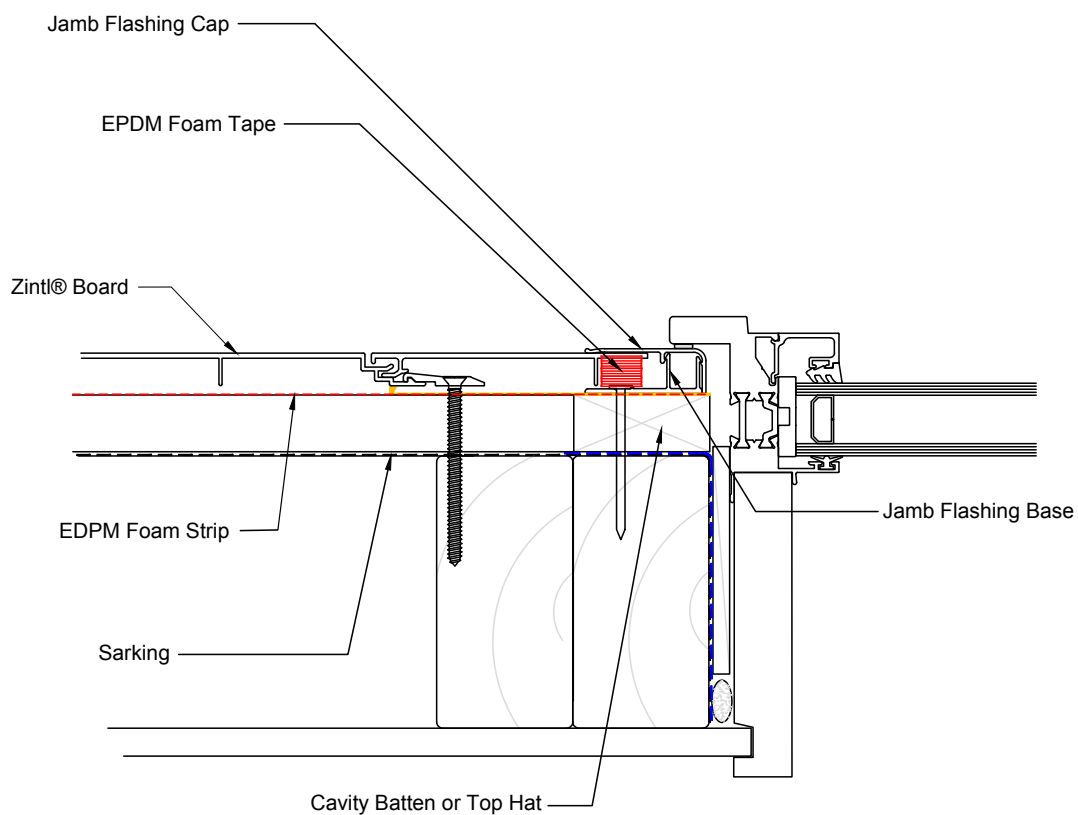

TYPICAL VERTICAL FIXING DETAIL

This information is generic in nature and supplied for guidance purposes only. Top Hat dimensions are nominal. Dimensions, spacing, spans and stiffener requirements will need to be confirmed by a suitably qualified professional to suit the specific application.

By **HVG** façades

hvgfacades.com.au

1300 881 712

info@hvgfacades.com.au

Vertical Cladding Window Head

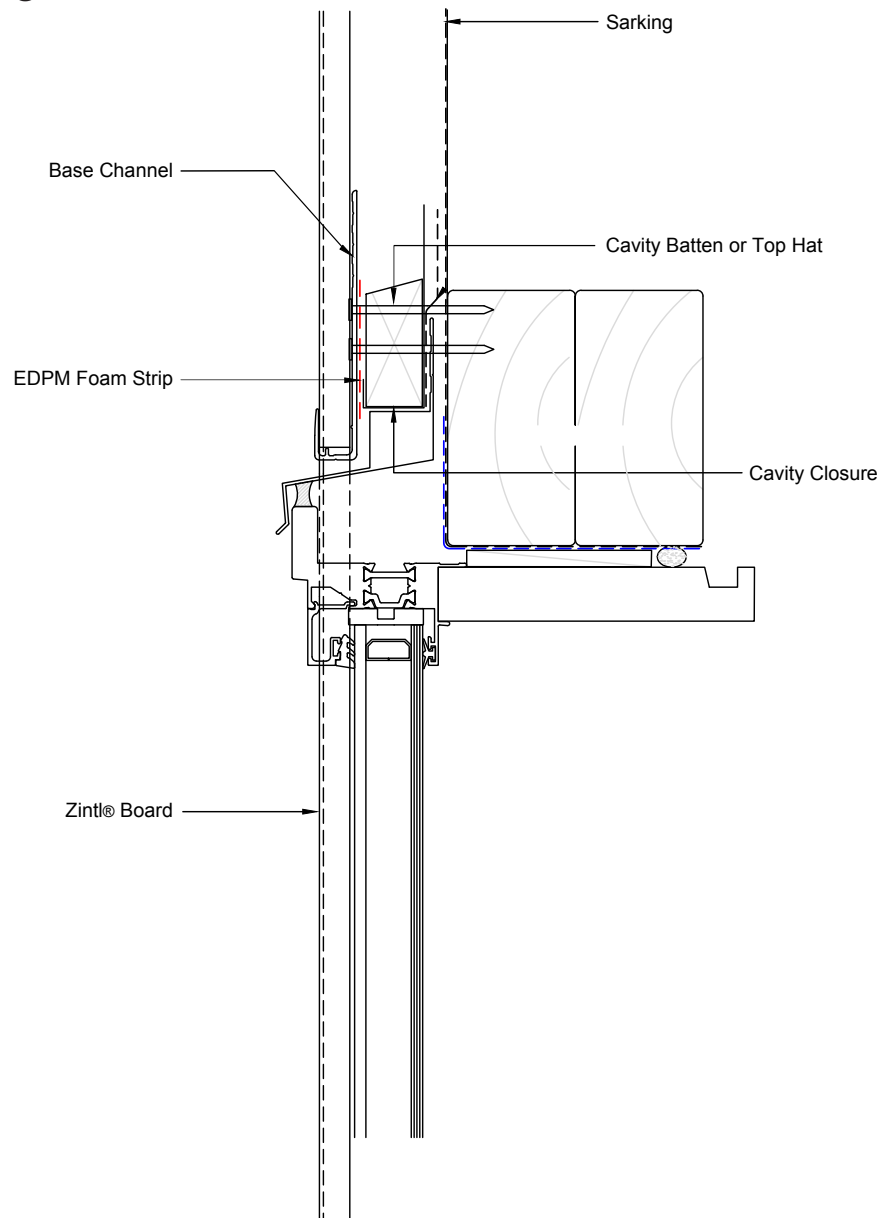

TYPICAL VERTICAL FIXING DETAIL

This information is generic in nature and supplied for guidance purposes only. Top Hat dimensions are nominal. Dimensions, spacing, spans and stiffener requirements will need to be confirmed by a suitably qualified professional to suit the specific application.

By **HVG** façades

hvgfacades.com.au

1300 881 712

info@hvgfacades.com.au

Vertical Cladding Meter Box Sill

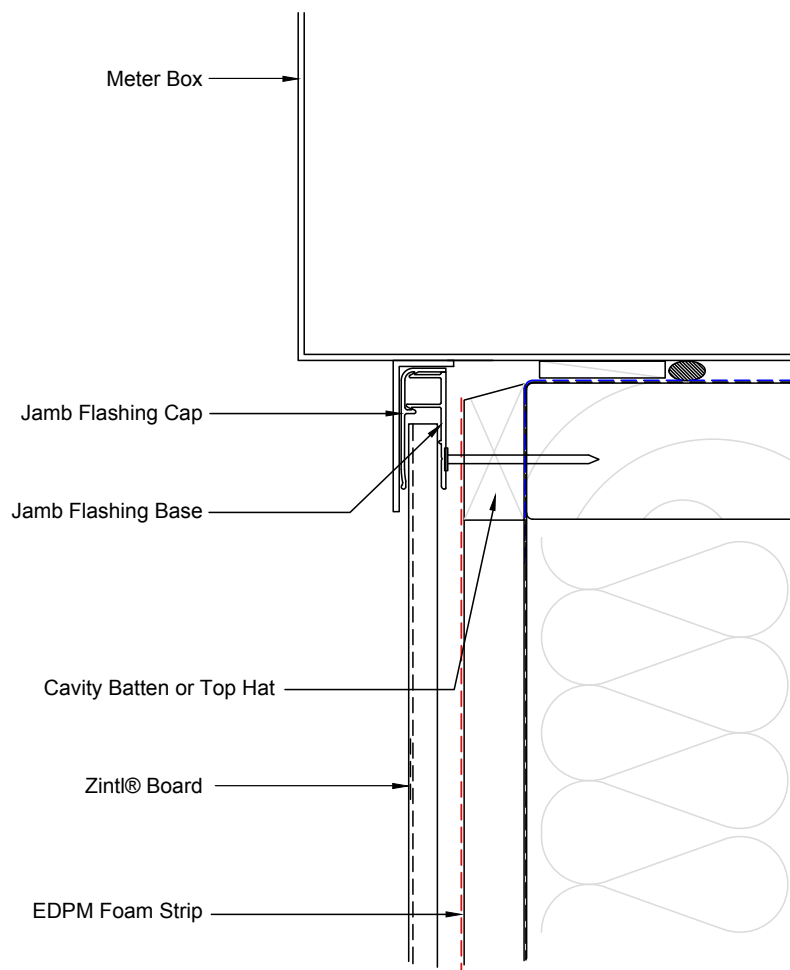

TYPICAL VERTICAL FIXING DETAIL

This information is generic in nature and supplied for guidance purposes only. Top Hat dimensions are nominal. Dimensions, spacing, spans and stiffener requirements will need to be confirmed by a suitably qualified professional to suit the specific application.

By **HVG** façades

hvgfacades.com.au

1300 881 712

info@hvgfacades.com.au

Vertical Cladding Meter Box Head

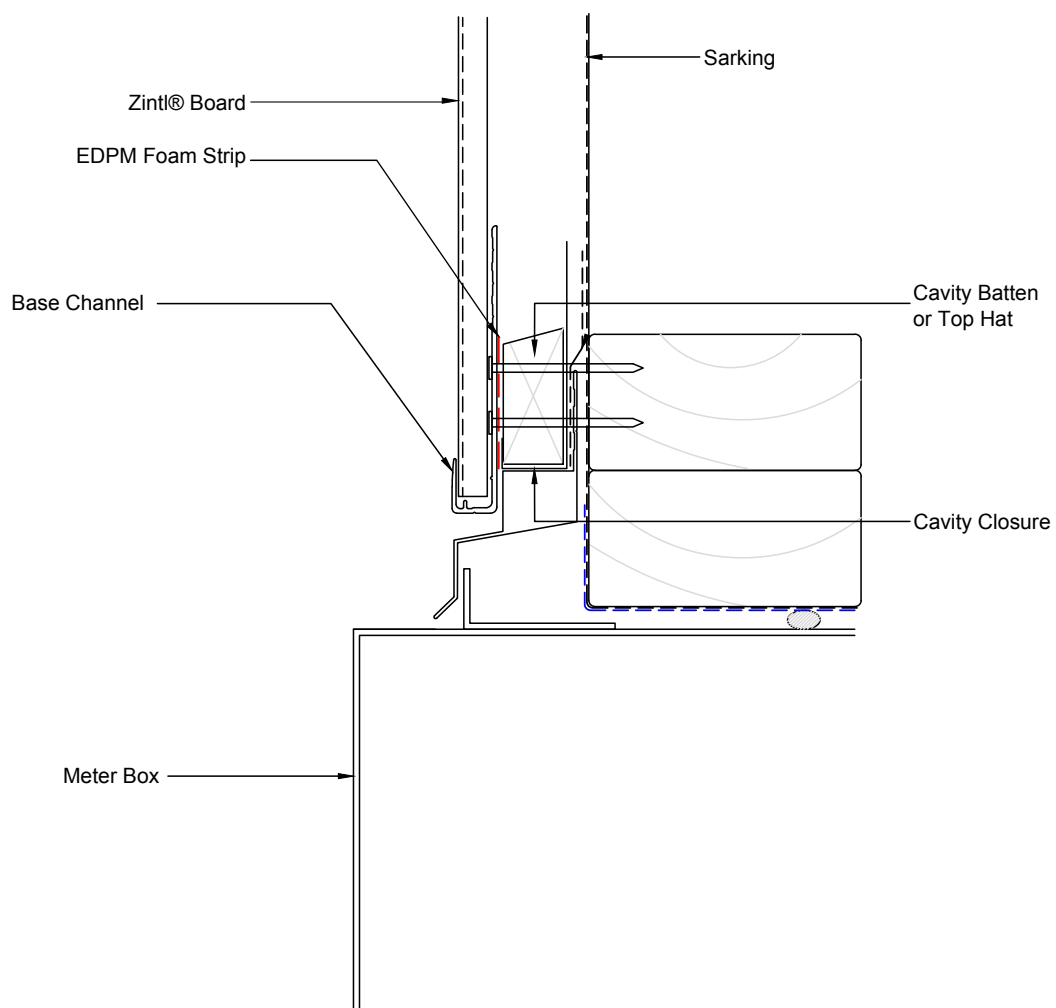

TYPICAL VERTICAL FIXING DETAIL

This information is generic in nature and supplied for guidance purposes only. Top Hat dimensions are nominal. Dimensions, spacing, spans and stiffener requirements will need to be confirmed by a suitably qualified professional to suit the specific application.

By **HVG** façades

hvgfacades.com.au

1300 881 712

info@hvgfacades.com.au

Vertical Cladding Softfit Trim

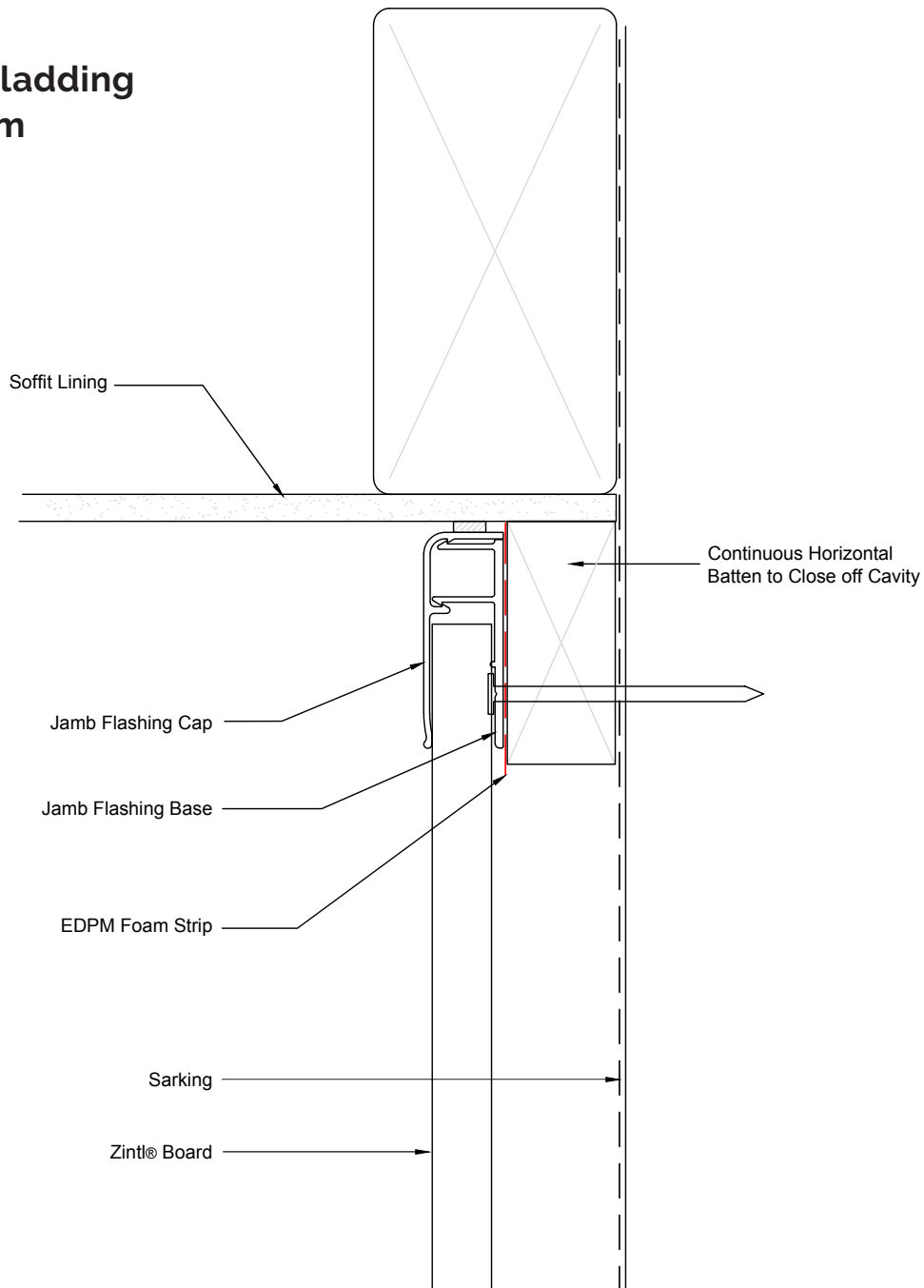

TYPICAL VERTICAL FIXING DETAIL

This information is generic in nature and supplied for guidance purposes only. Top Hat dimensions are nominal. Dimensions, spacing, spans and stiffener requirements will need to be confirmed by a suitably qualified professional to suit the specific application.

By **HVG** façades

hvgfacades.com.au

1300 881 712

info@hvgfacades.com.au

Vertical Cladding Roof / Wall Junction

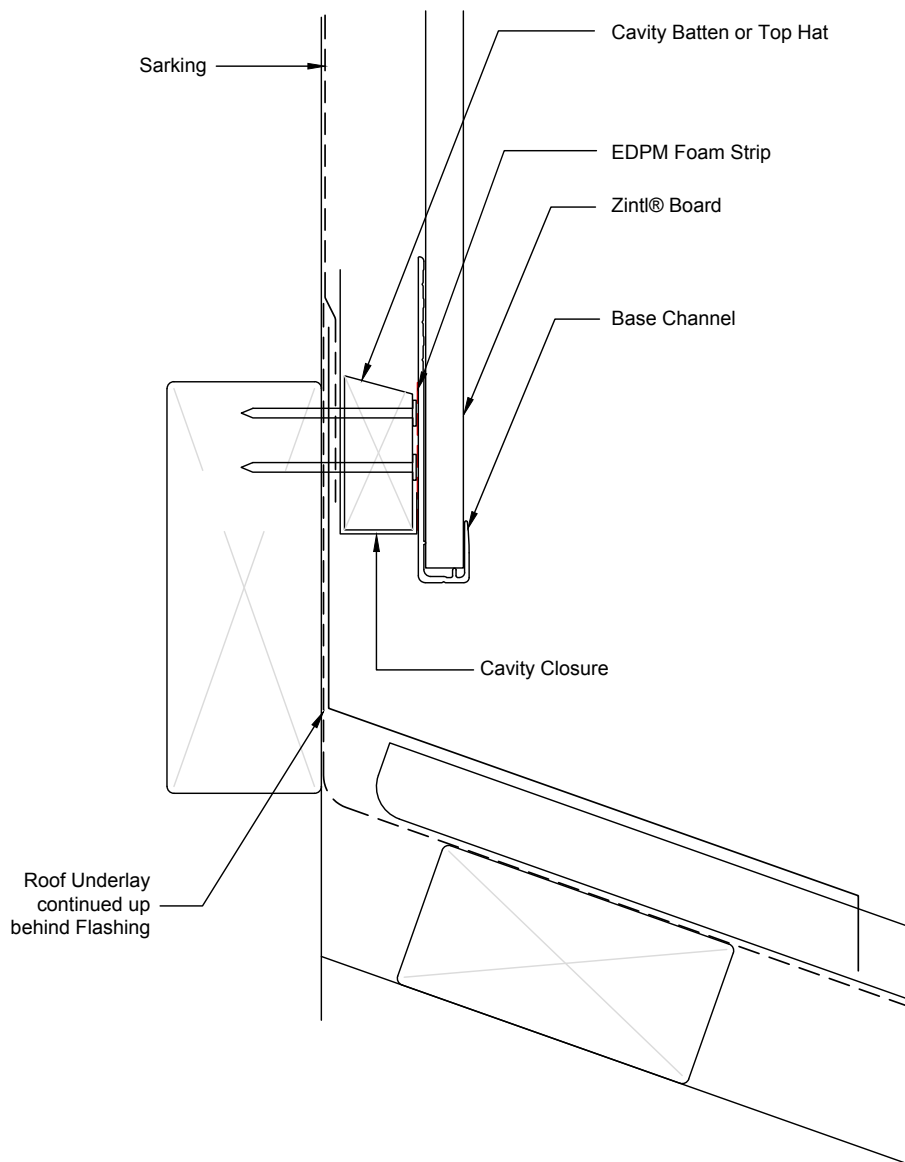

TYPICAL VERTICAL FIXING DETAIL

This information is generic in nature and supplied for guidance purposes only. Top Hat dimensions are nominal. Dimensions, spacing, spans and stiffener requirements will need to be confirmed by a suitably qualified professional to suit the specific application.

By **HVG** façades

hvgfacades.com.au

1300 881 712

info@hvgfacades.com.au

Vertical Cladding Parapet Flashing

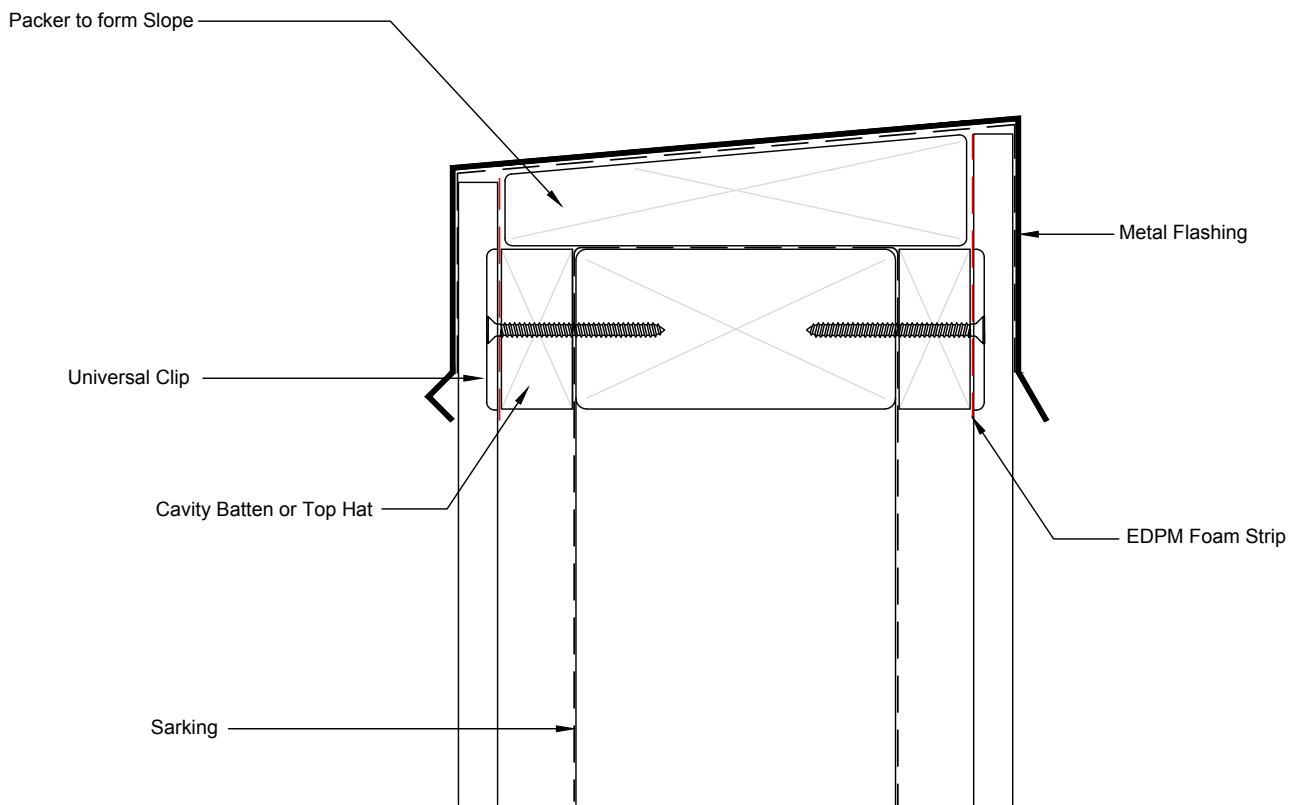

TYPICAL VERTICAL FIXING DETAIL

This information is generic in nature and supplied for guidance purposes only. Top Hat dimensions are nominal. Dimensions, spacing, spans and stiffener requirements will need to be confirmed by a suitably qualified professional to suit the specific application.

By **HVG** façades

hvgfacades.com.au

1300 881 712

info@hvgfacades.com.au