

ZINTL®

TYPICAL HORIZONTAL FIXING DETAIL

Horizontal Cladding Wall Layout

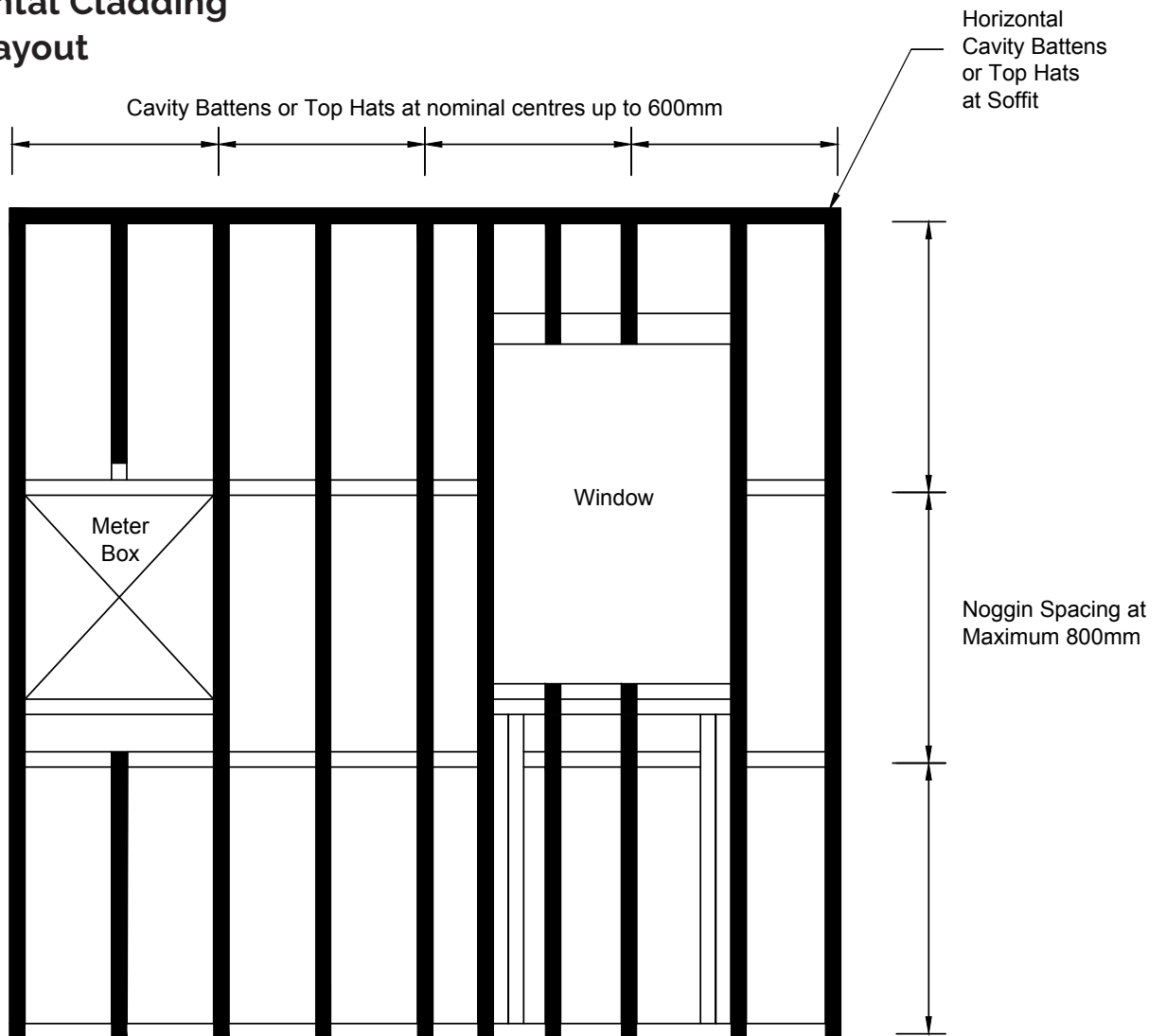

TYPICAL HORIZONTAL FIXING DETAIL

This information is generic in nature and supplied for guidance purposes only. Top Hat dimensions are nominal. Dimensions, spacing, spans and stiffener requirements will need to be confirmed by a suitably qualified professional to suit the specific application.

By **HVG** façades

hvgfacades.com.au

1300 881 712

info@hvgfacades.com.au

Horizontal Cladding Wall Starter

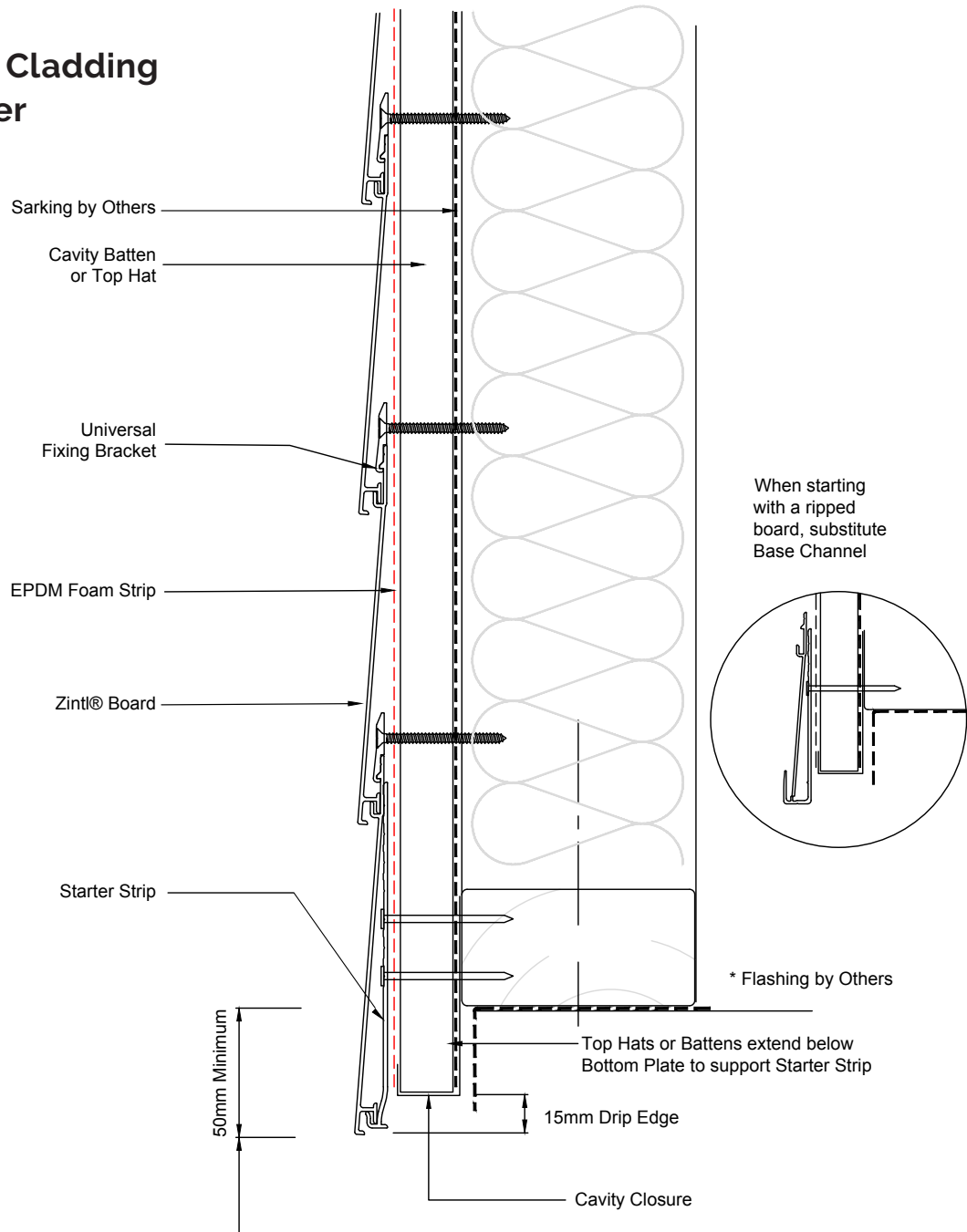

TYPICAL HORIZONTAL FIXING DETAIL

This information is generic in nature and supplied for guidance purposes only. Top Hat dimensions are nominal. Dimensions, spacing, spans and stiffener requirements will need to be confirmed by a suitably qualified professional to suit the specific application.

By **HVG** façades

hvgfacades.com.au

1300 881 712

info@hvgfacades.com.au

Horizontal Cladding External Corner

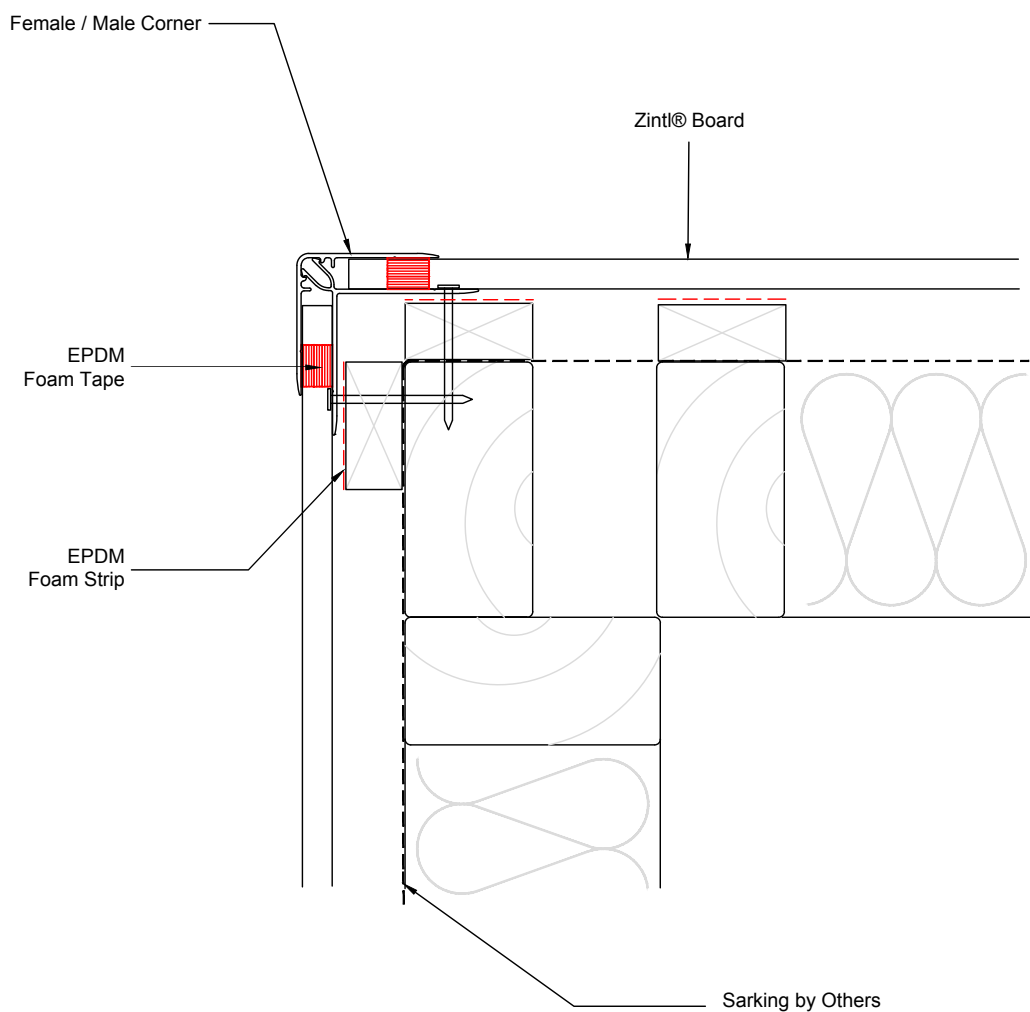

TYPICAL HORIZONTAL FIXING DETAIL

This information is generic in nature and supplied for guidance purposes only. Top Hat dimensions are nominal. Dimensions, spacing, spans and stiffener requirements will need to be confirmed by a suitably qualified professional to suit the specific application.

By **HVG** façades

hvgfacades.com.au

1300 881 712

info@hvgfacades.com.au

Horizontal Cladding Internal Corner

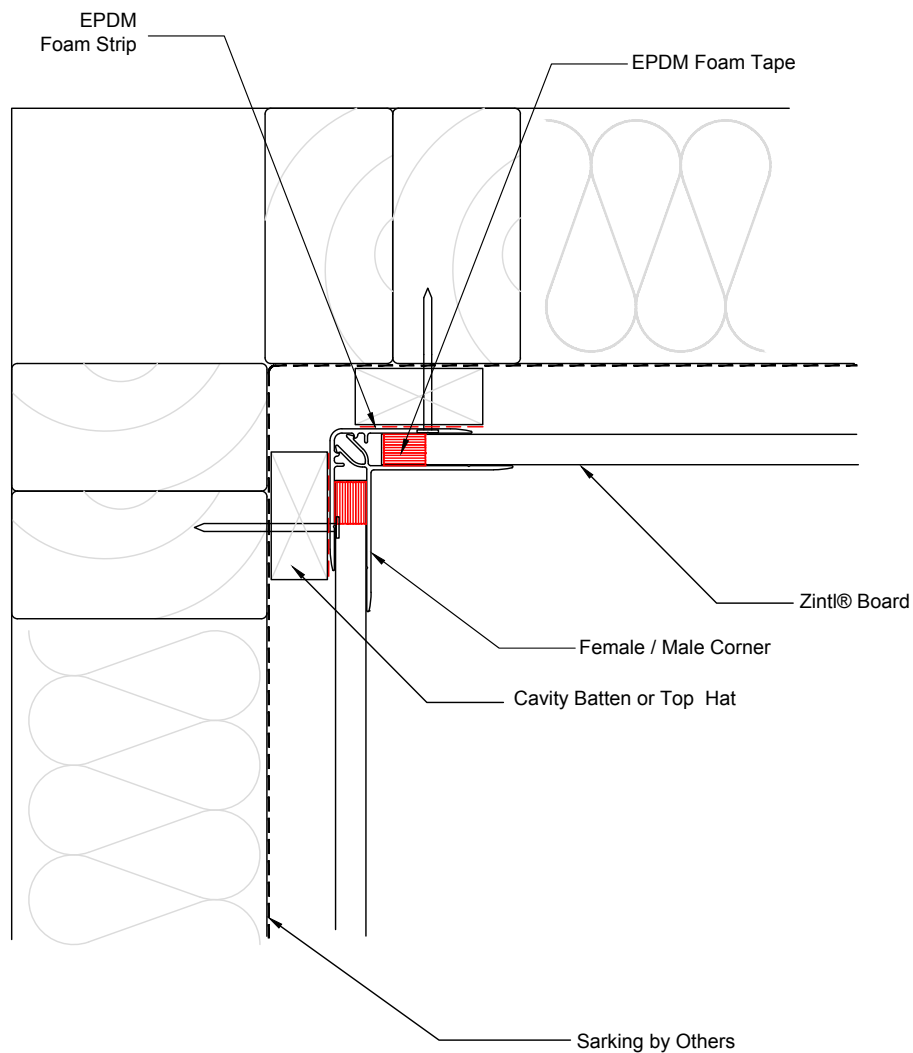

TYPICAL HORIZONTAL FIXING DETAIL

This information is generic in nature and supplied for guidance purposes only. Top Hat dimensions are nominal. Dimensions, spacing, spans and stiffener requirements will need to be confirmed by a suitably qualified professional to suit the specific application.

By **HVG** façades

hvgfacades.com.au

1300 881 712

info@hvgfacades.com.au

Horizontal Cladding Inter-Storey Joint

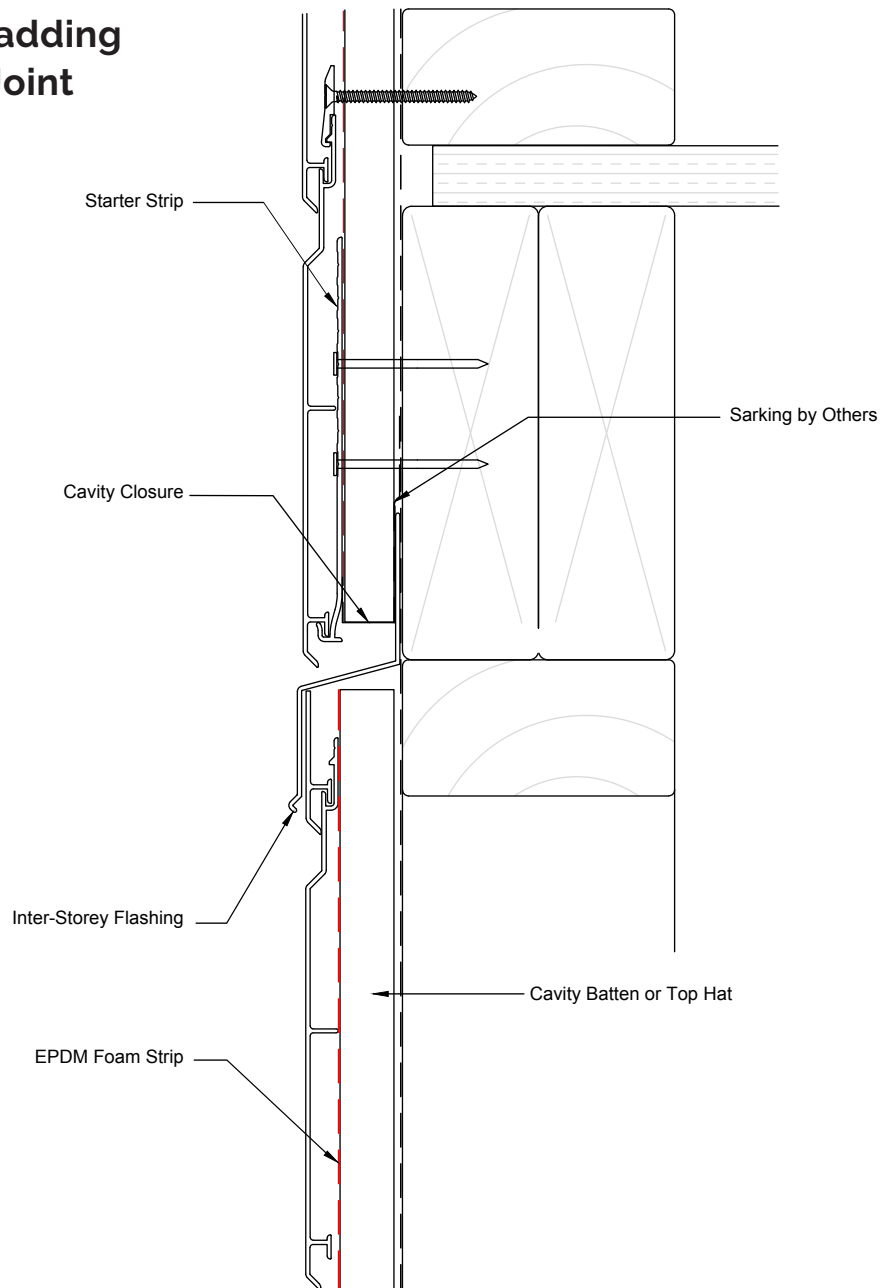

TYPICAL HORIZONTAL FIXING DETAIL

This information is generic in nature and supplied for guidance purposes only. Top Hat dimensions are nominal. Dimensions, spacing, spans and stiffener requirements will need to be confirmed by a suitably qualified professional to suit the specific application.

By **HVG** façades

hvgfacades.com.au

1300 881 712

info@hvgfacades.com.au

ZINTL®

TYPICAL HORIZONTAL FIXING DETAIL

Horizontal Cladding Vertical Joint

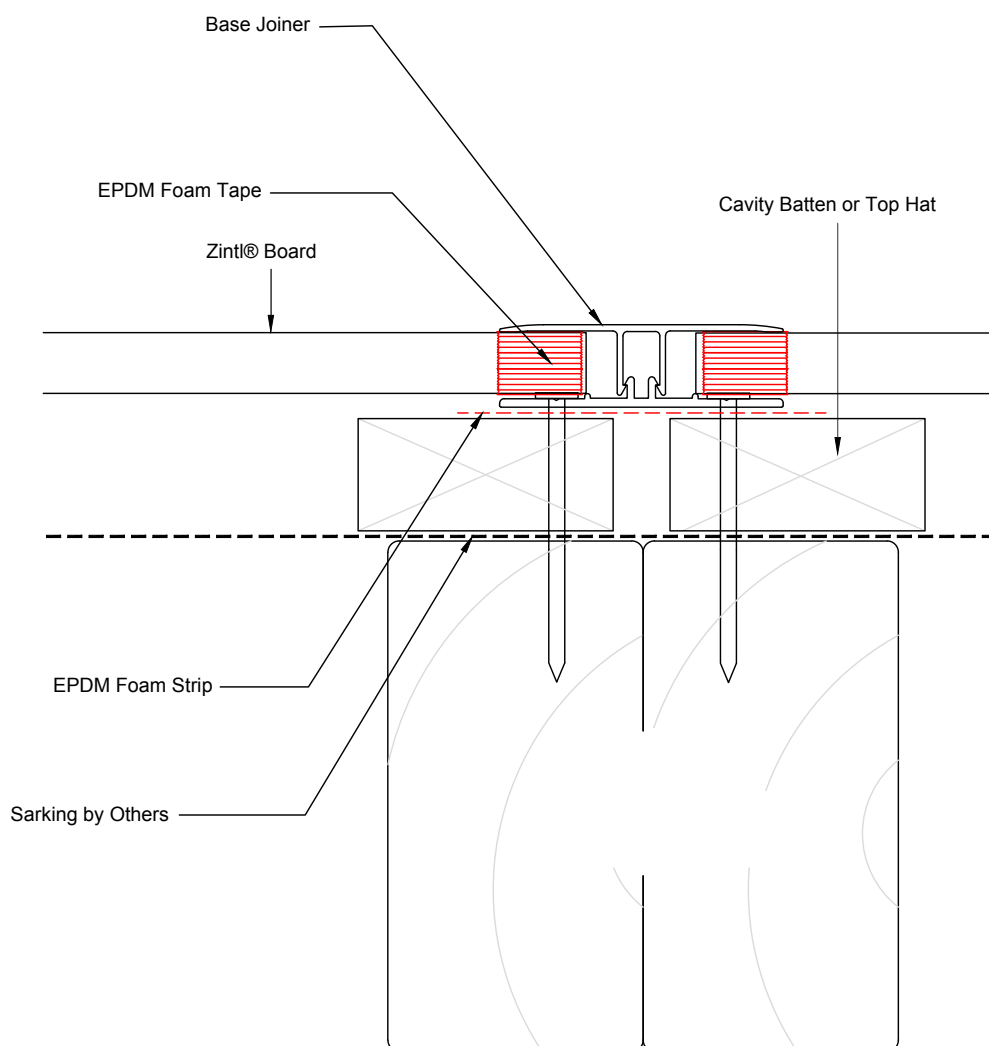

TYPICAL HORIZONTAL FIXING DETAIL

This information is generic in nature and supplied for guidance purposes only. Top Hat dimensions are nominal. Dimensions, spacing, spans and stiffener requirements will need to be confirmed by a suitably qualified professional to suit the specific application.

By **HVG** façades

hvgfacades.com.au

1300 881 712

info@hvgfacades.com.au

Horizontal Cladding Window Sill

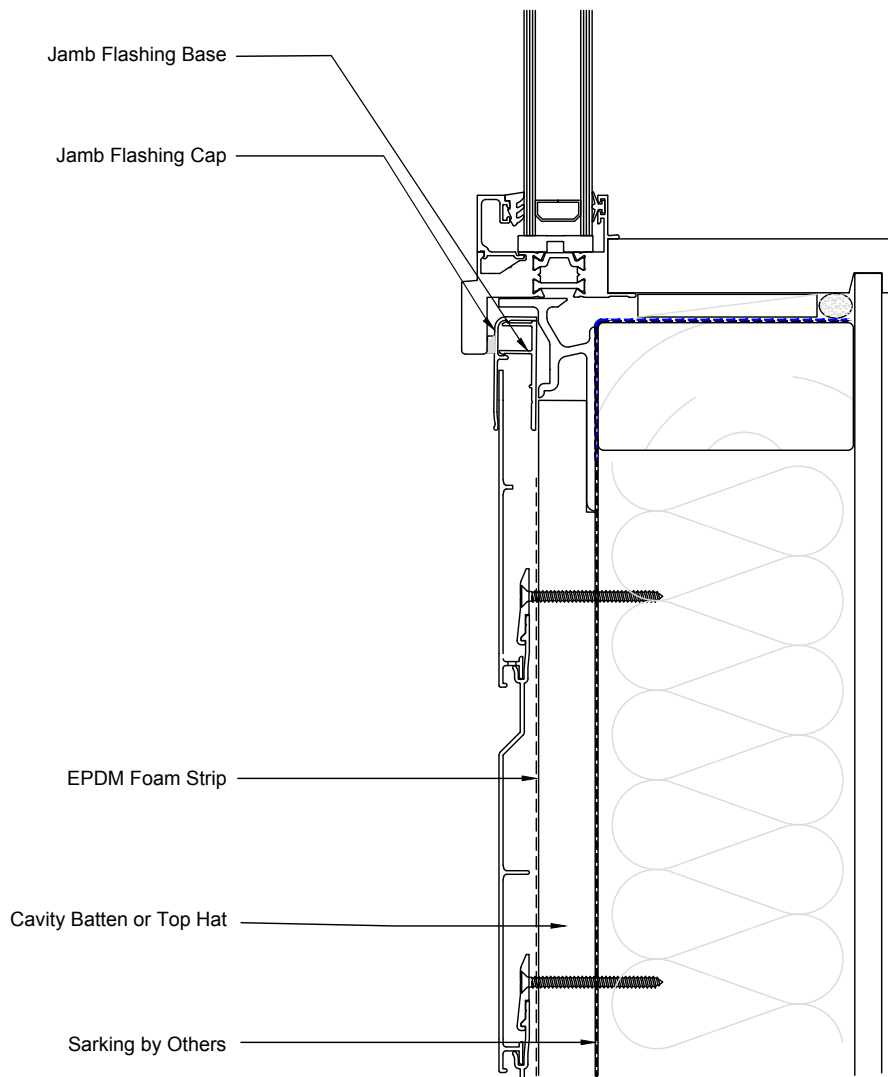

TYPICAL HORIZONTAL FIXING DETAIL

This information is generic in nature and supplied for guidance purposes only. Top Hat dimensions are nominal. Dimensions, spacing, spans and stiffener requirements will need to be confirmed by a suitably qualified professional to suit the specific application.

By **HVG** façades

hvgfacades.com.au

1300 881 712

info@hvgfacades.com.au

ZINTL®

TYPICAL HORIZONTAL FIXING DETAIL

Horizontal Cladding Window Jamb

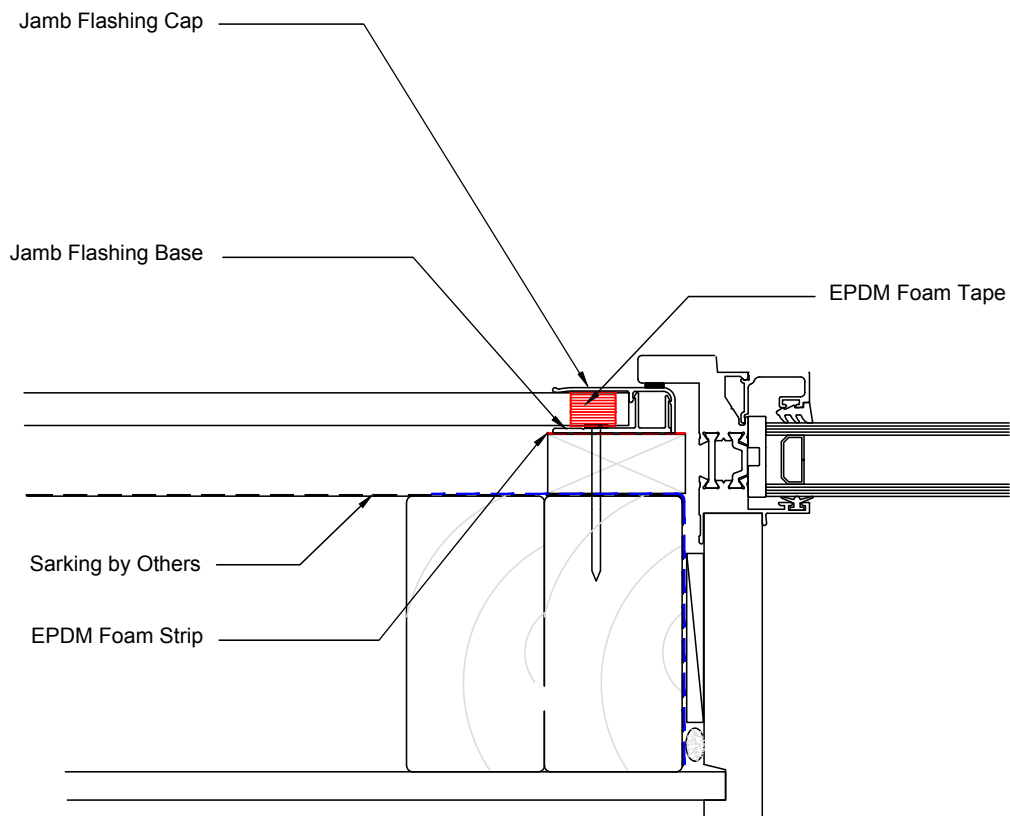

TYPICAL HORIZONTAL FIXING DETAIL

This information is generic in nature and supplied for guidance purposes only. Top Hat dimensions are nominal. Dimensions, spacing, spans and stiffener requirements will need to be confirmed by a suitably qualified professional to suit the specific application.

By **HVG** façades

hvgfacades.com.au

1300 881 712

info@hvgfacades.com.au

Horizontal Cladding Window Head

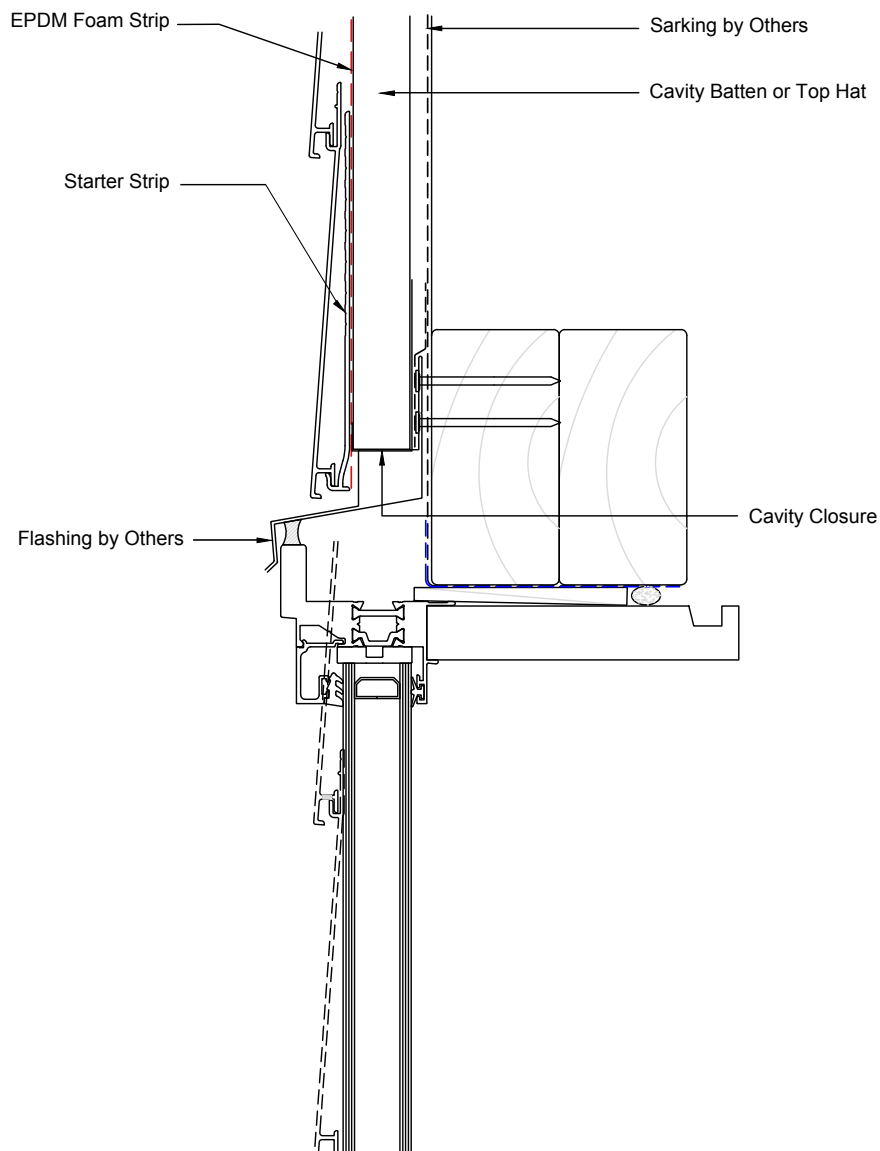

TYPICAL HORIZONTAL FIXING DETAIL

This information is generic in nature and supplied for guidance purposes only. Top Hat dimensions are nominal. Dimensions, spacing, spans and stiffener requirements will need to be confirmed by a suitably qualified professional to suit the specific application.

By **HVG** façades

hvgfacades.com.au

1300 881 712

info@hvgfacades.com.au

ZINTL®

TYPICAL HORIZONTAL FIXING DETAIL

Horizontal Cladding Meter Box Sill

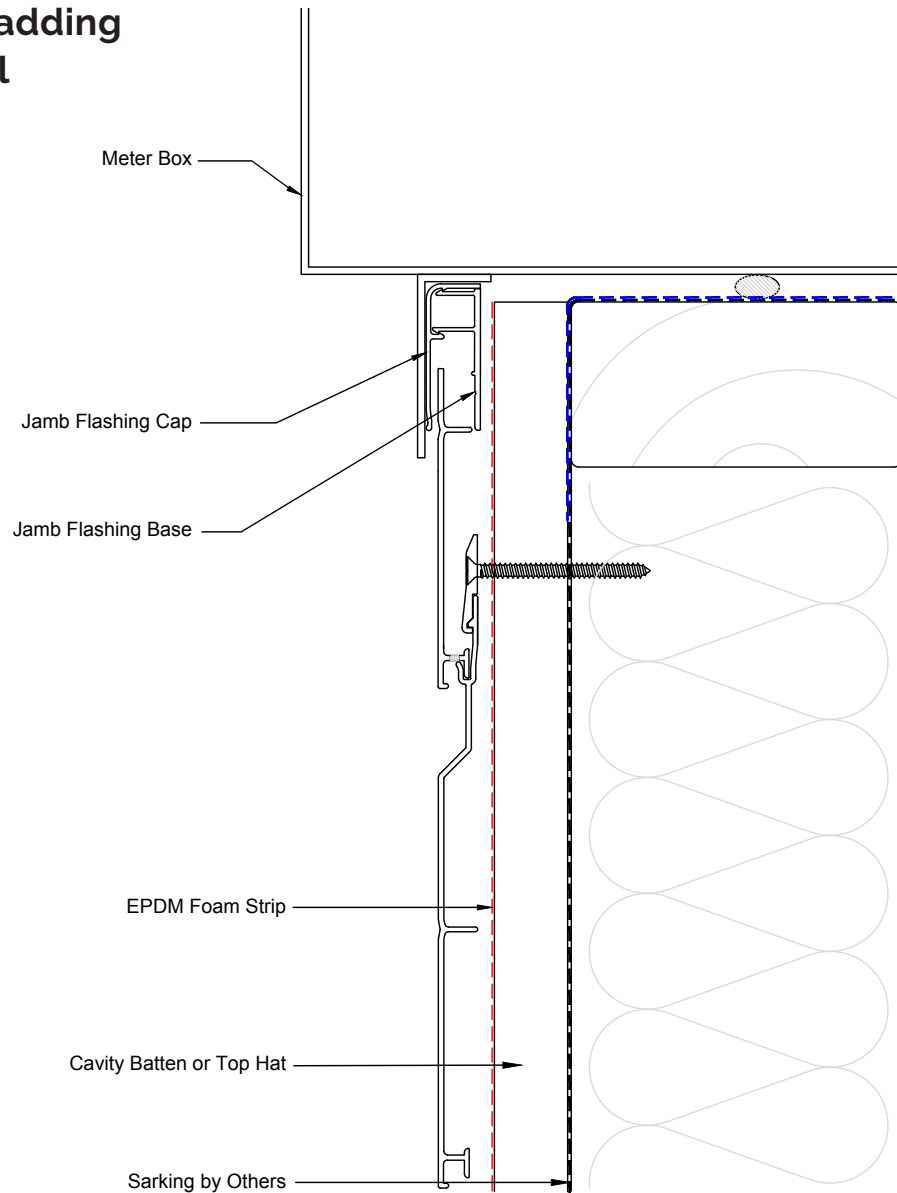

TYPICAL HORIZONTAL FIXING DETAIL

This information is generic in nature and supplied for guidance purposes only. Top Hat dimensions are nominal. Dimensions, spacing, spans and stiffener requirements will need to be confirmed by a suitably qualified professional to suit the specific application.

By **HVG** façades

hvgfacades.com.au

1300 881 712

info@hvgfacades.com.au

Horizontal Cladding Meter Box Jamb

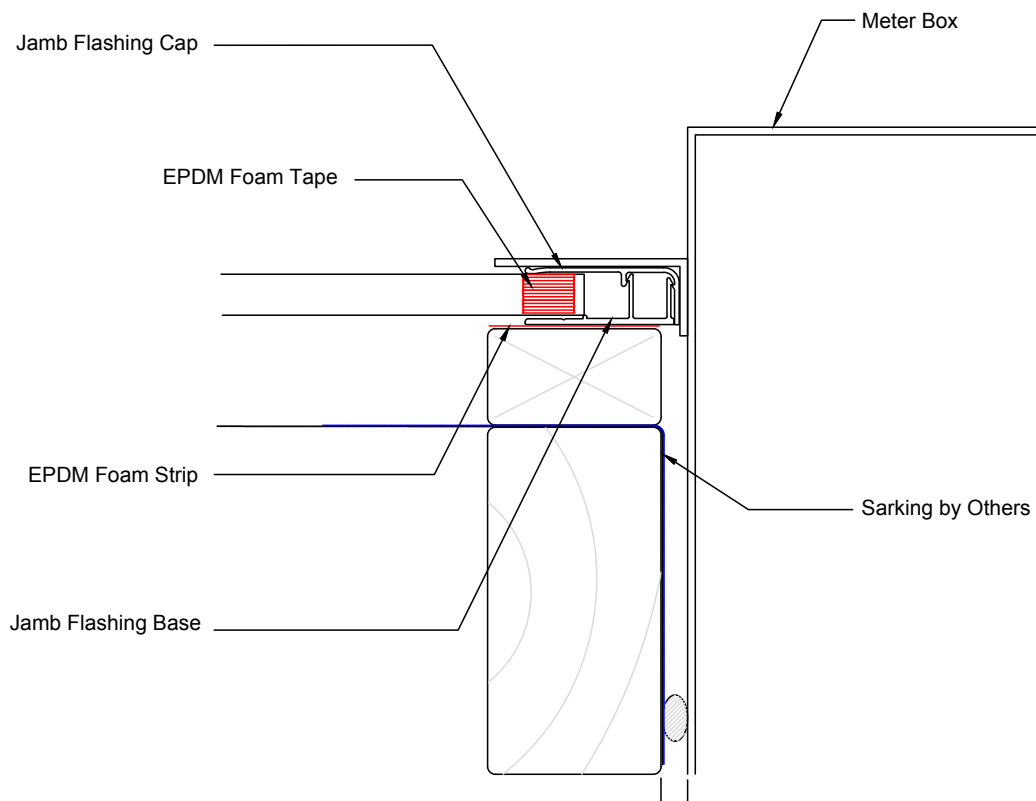

TYPICAL HORIZONTAL FIXING DETAIL

This information is generic in nature and supplied for guidance purposes only. Top Hat dimensions are nominal. Dimensions, spacing, spans and stiffener requirements will need to be confirmed by a suitably qualified professional to suit the specific application.

By **HVG** façades

hvgfacades.com.au

1300 881 712

info@hvgfacades.com.au

Horizontal Cladding Meter Box Head

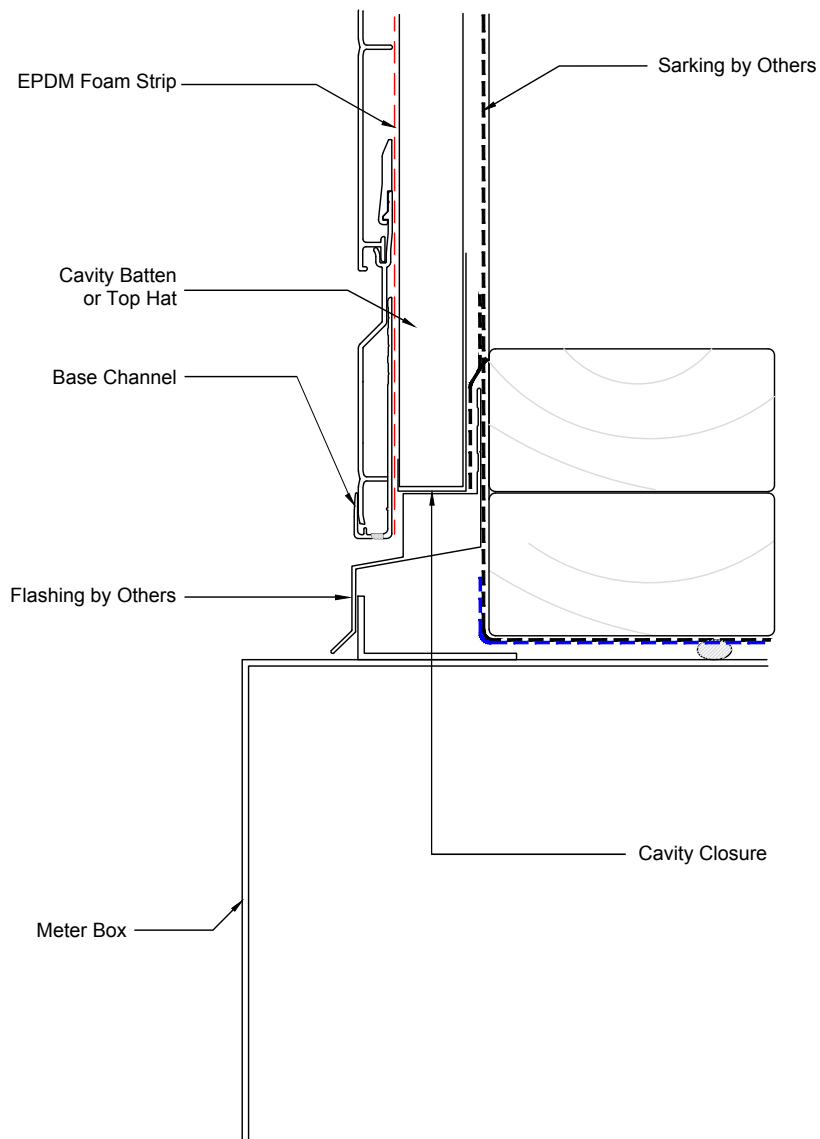

TYPICAL HORIZONTAL FIXING DETAIL

This information is generic in nature and supplied for guidance purposes only. Top Hat dimensions are nominal. Dimensions, spacing, spans and stiffener requirements will need to be confirmed by a suitably qualified professional to suit the specific application.

By **HVG** façades

hvgfacades.com.au

1300 881 712

info@hvgfacades.com.au

Horizontal Cladding Roof / Wall Junction

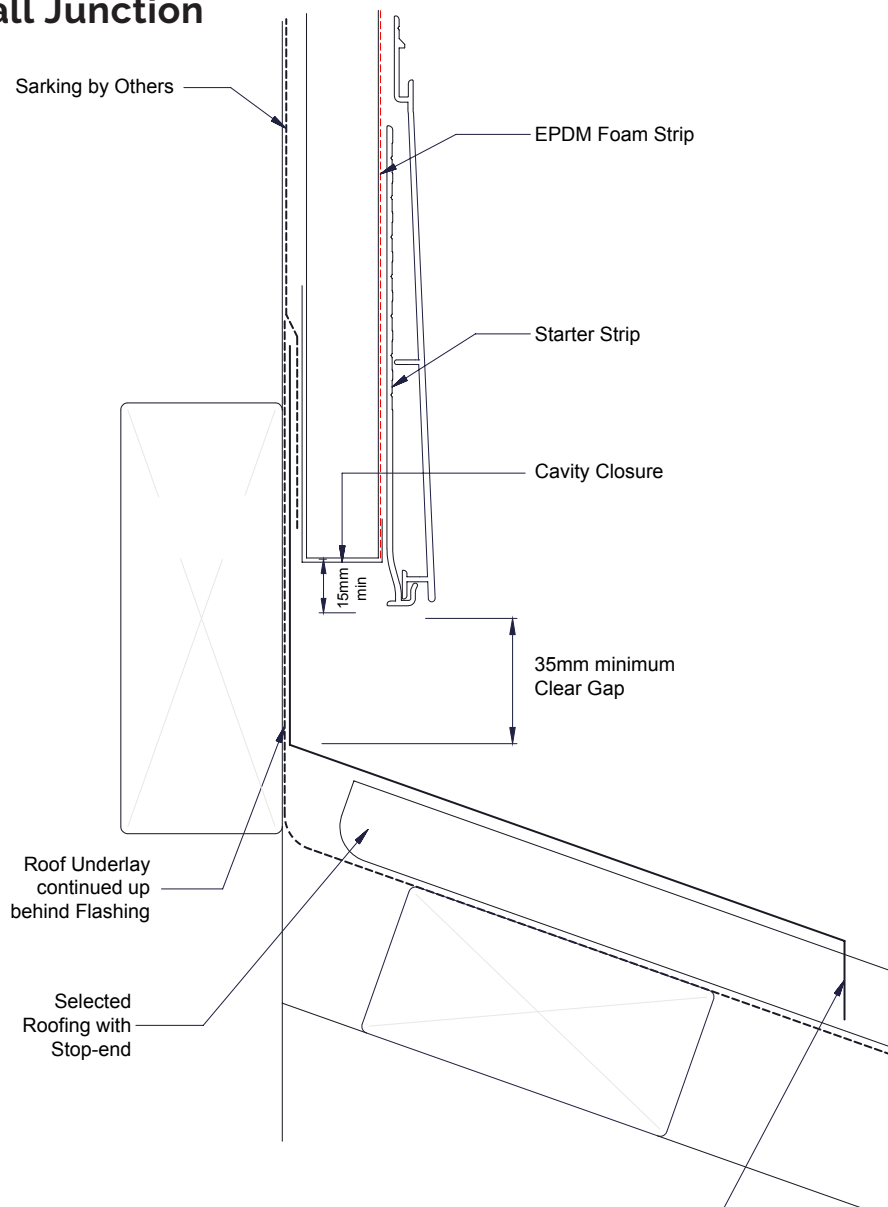

TYPICAL HORIZONTAL FIXING DETAIL

This information is generic in nature and supplied for guidance purposes only. Top Hat dimensions are nominal. Dimensions, spacing, spans and stiffener requirements will need to be confirmed by a suitably qualified professional to suit the specific application.

By **HVG** façades

hvgfacades.com.au

1300 881 712

info@hvgfacades.com.au

Horizontal Cladding Parapet Flashing

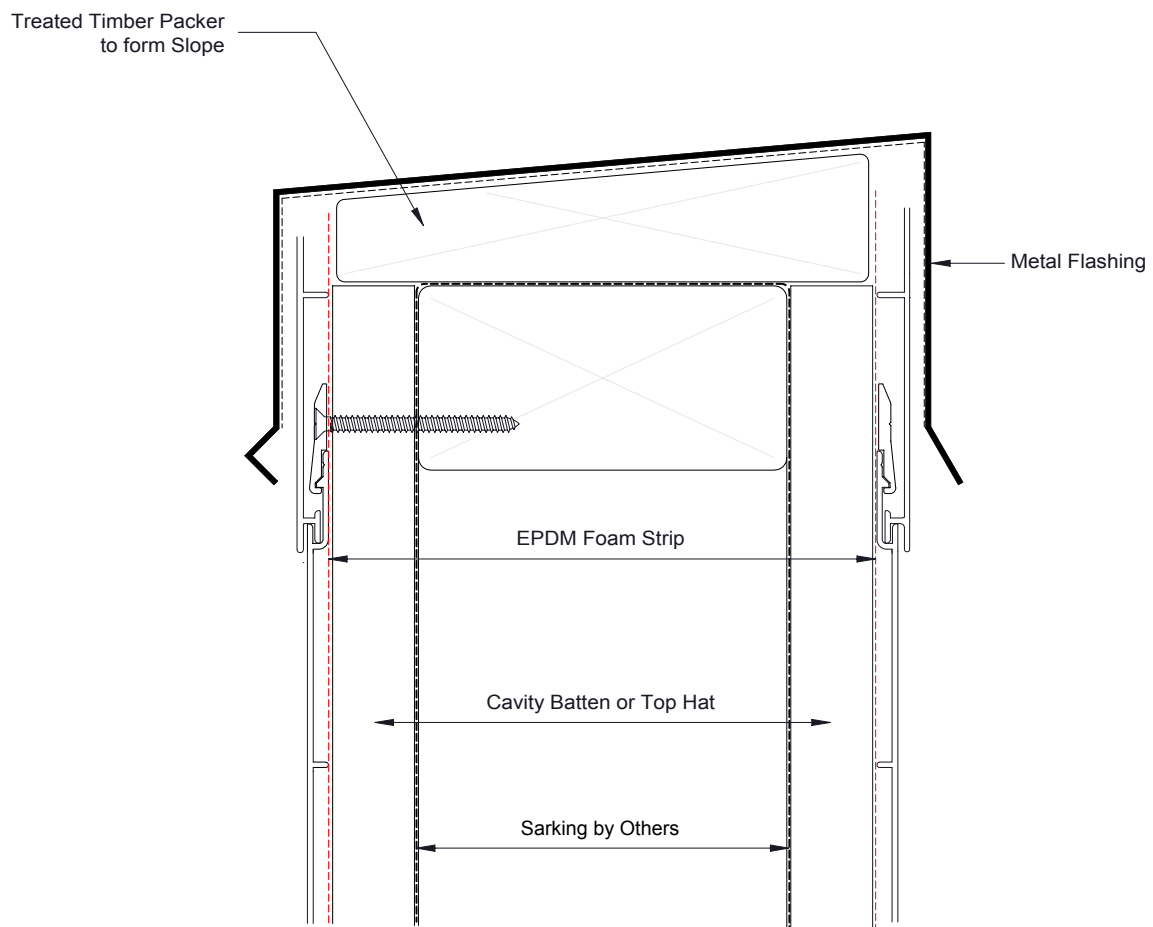

TYPICAL HORIZONTAL FIXING DETAIL

This information is generic in nature and supplied for guidance purposes only. Top Hat dimensions are nominal. Dimensions, spacing, spans and stiffener requirements will need to be confirmed by a suitably qualified professional to suit the specific application.

By **HVG** façades

hvgfacades.com.au

1300 881 712

info@hvgfacades.com.au